

DETAIL A

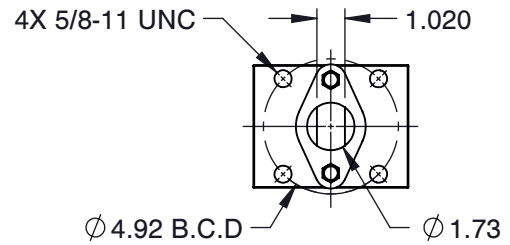

MOUNTING DIMENSIONS

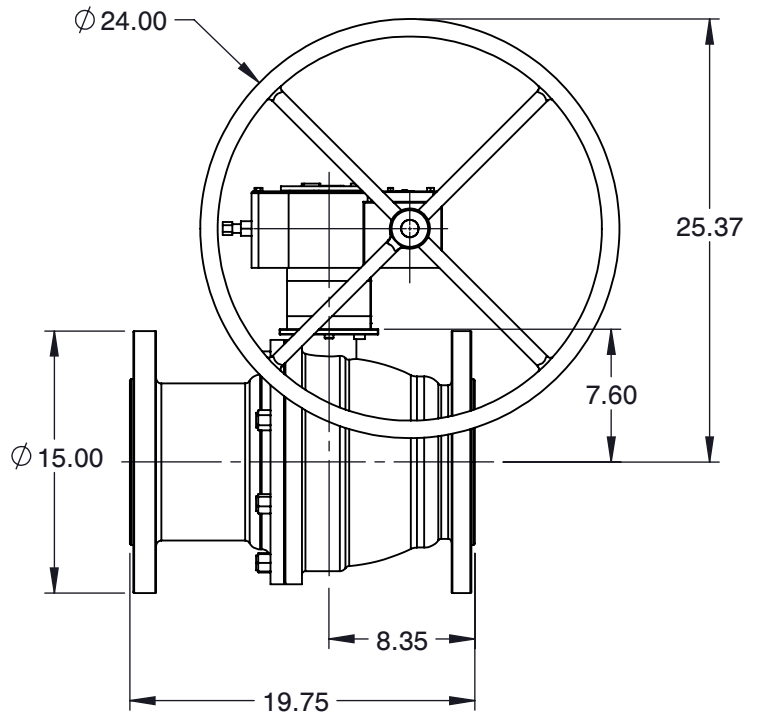
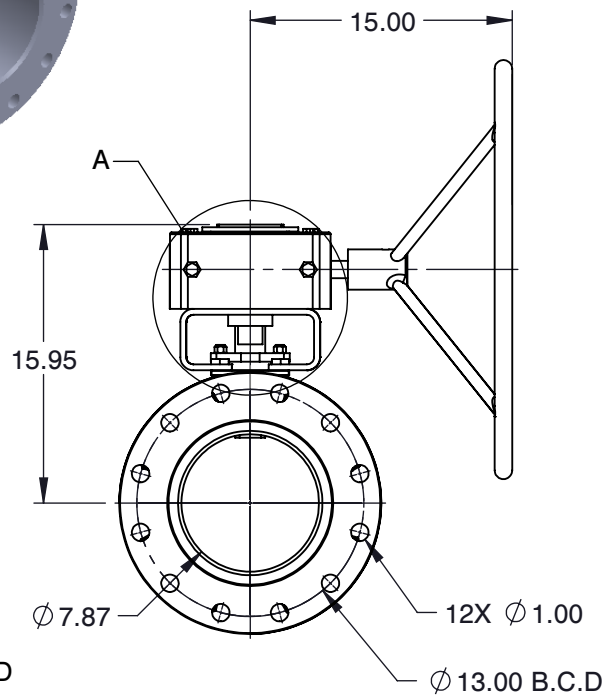

NOTES :

1. SIZE : 8"
2. PORT SIZE : FULL PORT
3. CLASS : 300#
4. END CONNECTION : FLANGED
5. WEIGHT : 371 LBS
6. Cv : 10000
7. PRESSURE RANGE : 720 PSI
8. TEMPERATURE RANGE : UP TO 1000°F



6910 West Ridge Road
 Fairview, PA 16415, USA
 Phone: (814) 474-2666
 Web: www.jareckivalves.net
 Email: sales@jareckivalves.net

THE INFORMATION CONTAINED HEREIN SHALL BE CONSIDERED THE SOLE PROPERTY OF JARECKI VALVES. THE RECIPIENT THEREOF AGREES NOT TO DISCLOSE SAID INFORMATION FOR ANY PURPOSE EXCEPT AS SPECIFIED BY JARECKI VALVES, BY WRITTEN PERMISSION.

Tolerances (Inch)
 .xx = ± .01
 .xxx = ± .005
 x° = ± 1°
 or As Note

SCALE NTS

COMPONENT		BALL VALVES	
8-SVF-03B/GO 300# ANSI SV SERIES 2-Piece Ball Valves		UNIT	
		INCH	
		SIZE	
		A	

ORDERING INFORMATION

SIZE	- SERIES	PORT SIZE	SEAT	SEAT MATERIAL	BALL	BALL COATING	BODY	- CLASS	END CONNECTION	OPTIONS
1/2" TO 12"	SV	F FULL R REDUCED	0 NONMETAL 1 O SEAT 2 G SEAT 4 P SEAT 5 P SEAT > 750F	B BORONIZING C COLMONOY G GRAPHITE M TANTALUM CHROME OXIDE P PEEK R CHROME CARBIDE S STELLITE T TFE U UHMWPE W TUNGSTEN CARBIDE	A 316SST F HASTELLOY G INCOLOY H ALLOY 20 I MONEL X 2205 SST	B BORONIZING C CHROME E ENP M TANTALUM CHROME OXIDE L COLMONOY R CHROME CARBIDE S STELLITE T TFE W TUNGSTEN CARBIDE O NO COATING	A CF8M B WCB H Alloy 20 X 2205 SST	01 150# 03 300#	B FLANGED D BUTT WELD	V90 90DEG V V60 60DEG V V30 30DEG V V15 15DEG V SL12 SLOT.125 SL063 SLOT.063

Example:

2"	SV SERIES	FULL PORT	SPRING LOADED UNIDIRECTIONAL SEATS	STELLITE SEATS	316SS	CHROME	CF8M	150#	FLANGED RF
2	-SV	F	4	S	A	C	A	-01	B

Ordering Information:

When placing an order or requesting a quotation, please provide as many details on the application as possible such as media type, temperature, pressure, pipe size, etc.

				COMPONENT	BALL VALVES
	6910 West Ridge Road Fairview, PA 16415, USA Phone: (814) 474-2666 Web: www.jareckivalves.net Email: sales@jareckivalves.net	THE INFORMATION CONTAINED HEREIN SHALL BE CONSIDERED THE SOLE PROPERTY OF JARECKI VALVES. THE RECIPIENT THEREOF AGREES NOT TO DISCLOSE SAID INFORMATION FOR ANY PURPOSE EXCEPT AS SPECIFIED BY JARECKI VALVES, BY WRITTEN PERMISSION.	Tolerances (Inch) .xx = ± .01 .xxx = ± .005 x° = ± 1° or As Note	8-SVF-03B/GO 300# ANSI SV SERIES 2-Piece Ball Valves	UNIT
					INCH
			SIZE		
			A		
		SCALE	NTS		