

DETAIL A

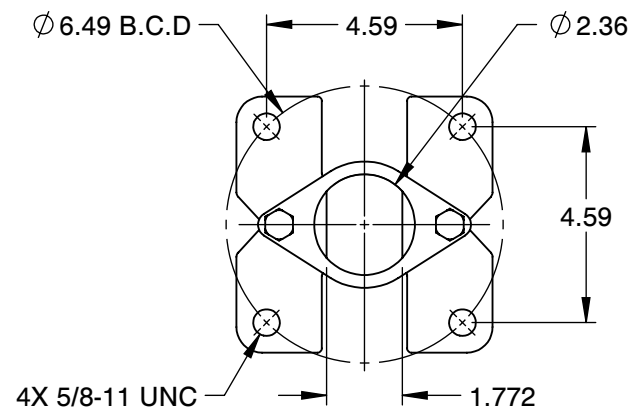

MOUNTING DIMENSIONS

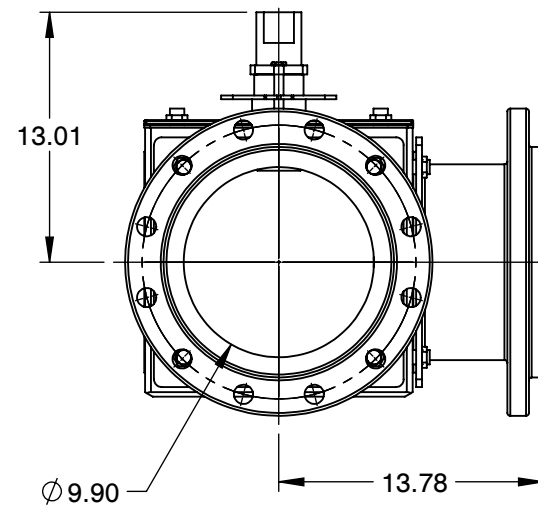
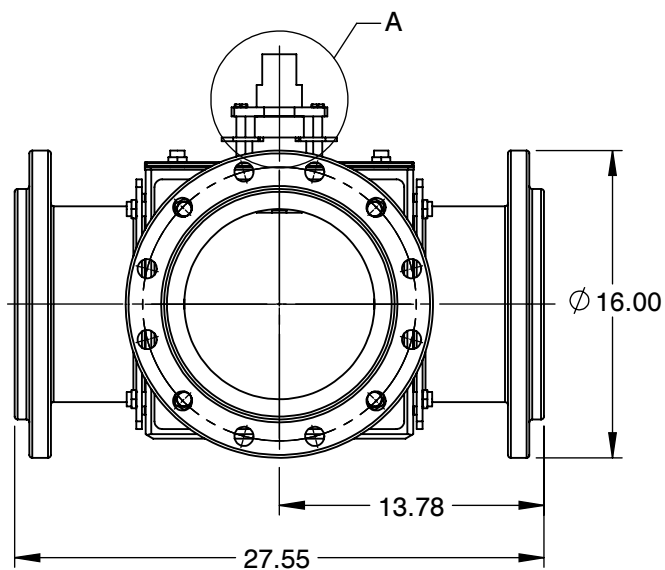

NOTES :

1. SIZE : 10"
2. PORT SIZE : FULL PORT
3. END CONNECTION : RF-FLANGED
4. PRESSURE RANGE : 740 PSI
5. TEMPERATURE RANGE : MAX UP TO 1000°F



6910 West Ridge Road
 Fairview, PA 16415, USA
 Phone: (814) 474-2666
 Web: www.jareckivalves.net
 Email: sales@jareckivalves.net

THE INFORMATION CONTAINED HEREIN SHALL BE CONSIDERED THE SOLE PROPERTY OF JARECKI VALVES. THE RECIPIENT THEREOF AGREES NOT TO DISCLOSE SAID INFORMATION FOR ANY PURPOSE EXCEPT AS SPECIFIED BY JARECKI VALVES, BY WRITTEN PERMISSION.

Tolerances (Inch)
 .xx = ± .01
 .xxx = ± .005
 x° = ± 1°
 or As Note

SCALE

NTS

COMPONENT	BALL VALVES
10-MDVF-03B 300# ANSI MDV SERIES 3-Way Ball Valves	UNIT
	INCH
	SIZE
	A

ORDERING INFORMATION

SIZE	- SERIES	PORT SIZE	SEAT	SEAT MATERIAL	BALL	BALL COATING	BODY	- CLASS	END CONNECTION	END CONNECTION
3/4" TO 12"	MDV	F FULL R REDUCED	0 NONMETAL	B BORONIZING	A 316SST	B BORONIZING	A 316SST	01 150#	A NPT	F1 FLOW PLAN 1
			1 O SEAT	C COLMONOY	B A105	C CHROME	B A105	03 300#	B FLANGED	F2 FLOW PLAN 2
			2 G SEAT	G GRAPHITE	C F-22	E ENP	C F-22	06 600#	C RTJ FLANGED	F3 FLOW PLAN 3
			4 P SEAT	M TANTALUM	D INCONEL	M TANTALUM	D INCONEL	09 900#	D BUTT WELD	F4 FLOW PLAN 4
			5 P SEAT	CHROME OXIDE	E 304SST	CHROME OXIDE	E 304SST	15 1500#	E SOCKET WELD	F5 FLOW PLAN 5
			750F TO 1000F	P PEEK	F HASTELLOY	L COLMONOY	F HASTELLOY	25 2500#		F6 FLOW PLAN 6
			6 G SEAL	R CHROME CARBIDE	G INCOLOY	R CHROME CARBIDE	G INCOLOY			F7 FLOW PLAN 7
			<1300 deg F	S STELLITE	H ALLOY 20	S STELLITE	H ALLOY 20			F8 FLOW PLAN 8
			UNI-DIRECTIONAL	T TFE	I MONEL	T TFE	I MONEL			F9 FLOW PLAN 9
7 G SEAL	U UHMWPE	J 316H	W TUNGSTEN CARBIDE	J 316H						
UNI-DIRECTIONAL	W TUNGSTEN CARBIDE	L 316L	O NO COATING	L 316L						
8 G SEAL		N Ni-AI-BRONZE		N Ni-AI-BRONZE						
<1500 deg F		R F-91		R F-91						
UNI-DIRECTIONAL		T TITANIUM		T TITANIUM						
9 P SEAT		X DUPLEX		X DUPLEX						
OD O-RING										

Example:

2"	MDV SERIES	FULL PORT	RTFE SEATS	316SST BALL WITH NO PLATING	316SST	CHROME	316SST	150#	FLANGED RF
2	-MDV	F	O	T	A	C	A	-01	B

Ordering Information:

When placing an order or requesting a quotation, please provide as many details on the application as possible such as media type, temperature, pressure, pipe size, etc.

				COMPONENT	BALL VALVES
 <p>6910 West Ridge Road Fairview, PA 16415, USA Phone: (814) 474-2666 Web: www.jareckivalves.net Email: sales@jareckivalves.net</p>	<p>THE INFORMATION CONTAINED HEREIN SHALL BE CONSIDERED THE SOLE PROPERTY OF JARECKI VALVES. THE RECIPIENT THEREOF AGREES NOT TO DISCLOSE SAID INFORMATION FOR ANY PURPOSE EXCEPT AS SPECIFIED BY JARECKI VALVES, BY WRITTEN PERMISSION.</p>	<p>Tolerances (Inch) .xx = ± .01 .xxx = ± .005 x° = ± 1° or As Note</p>		<p>10-MDVF-03B 300# ANSI</p> <p>MDV SERIES 3-Way Ball Valves</p>	UNIT
		SCALE	NTS		INCH
					SIZE
					A