

DETAIL A

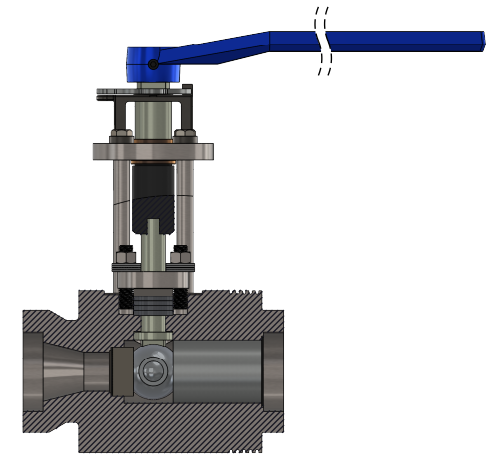

SECTION VIEW

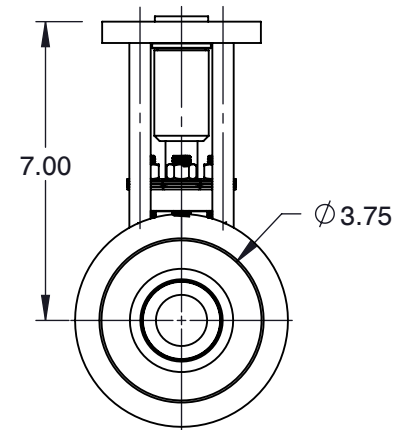
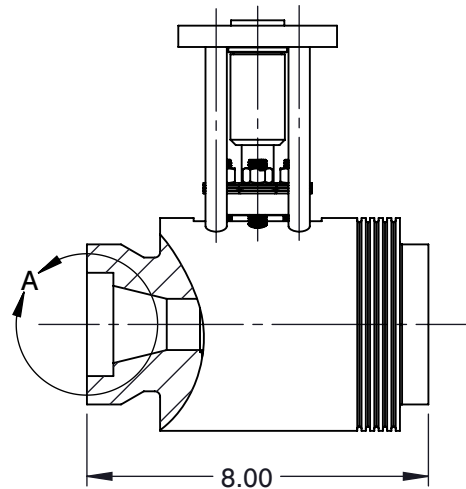

NOTES :

1. SIZE : 2"
2. BALL BORE DIAMETER : 1.20"
3. CLASS : 2500#
4. END CONNECTION : BUTT WELD
5. WEIGHT : 55 LBS
6. Cv : 70
7. PRESSURE RANGE : 6500 PSI
8. TEMPERATURE RANGE : UP TO 1200°F



6910 West Ridge Road
 Fairview, PA 16415, USA
 Phone: (814) 474-2666
 Web: www.jareckivalves.net
 Email: sales@jareckivalves.net

THE INFORMATION CONTAINED HEREIN SHALL BE CONSIDERED THE SOLE PROPERTY OF JARECKI VALVES. THE RECIPIENT THEREOF AGREES NOT TO DISCLOSE SAID INFORMATION FOR ANY PURPOSE EXCEPT AS SPECIFIED BY JARECKI VALVES, BY WRITTEN PERMISSION.

Tolerances (Inch)
 .xx = ± .01
 .xxx = ± .005
 x° = ± 1°
 or As Note

SCALE

NTS

COMPONENT	BALL VALVES	
2"-HTV-1.20-2BW 2500# ANSI HTV SERIES 1-Piece Ball Valves	UNIT	
	INCH	
	SIZE	
	A	

ORDERING INFORMATION

SIZE	- SERIES	BODY	VALVE TRIM	BALL SIZE	- CLASS	OPTIONS	ACTUATION	SOLENOID	LIMIT SWITCH	END CONNECTION
1/2" TO 4"	HTV	B A105	C 410 SST	0.50 .50" BALL BORE	06 600#	0 NO OPTION	L LEVER	0 NO OPTION	0 NO OPTION	SW SOCKET WELD
		C F-22	P 17-4 SST	0.63 .63" BALL BORE	09 900#	29 EXTENDED BONNET	DT8 DYNATORQUE DT8	S7AC 120 VAC	L1 MONITEUR	BW BUTT WELD
		J 316H	R INCONEL	0.88 .88" BALL BORE	1 1500#		DT12 DYNATORQUE DT12	S7DC 24 VDC	SA STONEL AXIOM	
		R F-91		1.00 1.0" BALL BORE	2 2500#		DT21 DYNATORQUE DT21			
		1 F-11		1.20 1.2" BALL BORE	3 3200#		125FC V-TORK 125			
				1.30 1.3" BALL BORE	4 4500#		140FC V-TORK 140			
				1.50 1.5" BALL BORE			160FC V-TORK 160			
							190FC V-TORK 190			
							210FC V-TORK 210			
							240FC V-TORK 240			
							270FC V-TORK 270			

Example:

2"	HTV SERIES	A105	17-4 SST WITH CHROME CARBIDE COAT	.88" BALL BORE	1500#	NO OPTION	LEVER	NO OPTION	MONITEUR LIMIT SWITCH	BUTT WELD
2	-HTV	B	P	0.88	-1	0	L	0	L1	BW

Ordering Information:

When placing an order or requesting a quotation, please provide as many details on the application as possible such as media type, temperature, pressure, pipe size, etc.

				COMPONENT	BALL VALVES	
 <p>6910 West Ridge Road Fairview, PA 16415, USA Phone: (814) 474-2666 Web: www.jareckivalves.net Email: sales@jareckivalves.net</p>	<p>THE INFORMATION CONTAINED HEREIN SHALL BE CONSIDERED THE SOLE PROPERTY OF JARECKI VALVES. THE RECIPIENT THEREIF AGREES NOT TO DISCLOSE SAID INFORMATION FOR ANY PURPOSE EXCEPT AS SPECIFIED BY JARECKI VALVES, BY WRITTEN PERMISSION.</p>	<p>Tolerances (Inch) .xx = ± .01 .xxx = ± .005 x° = ± 1° or As Note</p>		<p>2"-HTV-1.20-2BW 2500# ANSI</p>	UNIT	
		SCALE	NTS		HTV SERIES 1-Piece Ball Valves	INCH
						SIZE
						A